

Osaki

Smart Class **MASSAGE CHAIR**
Aster Operation Instructions

SAVE THESE INSTRUCTIONS

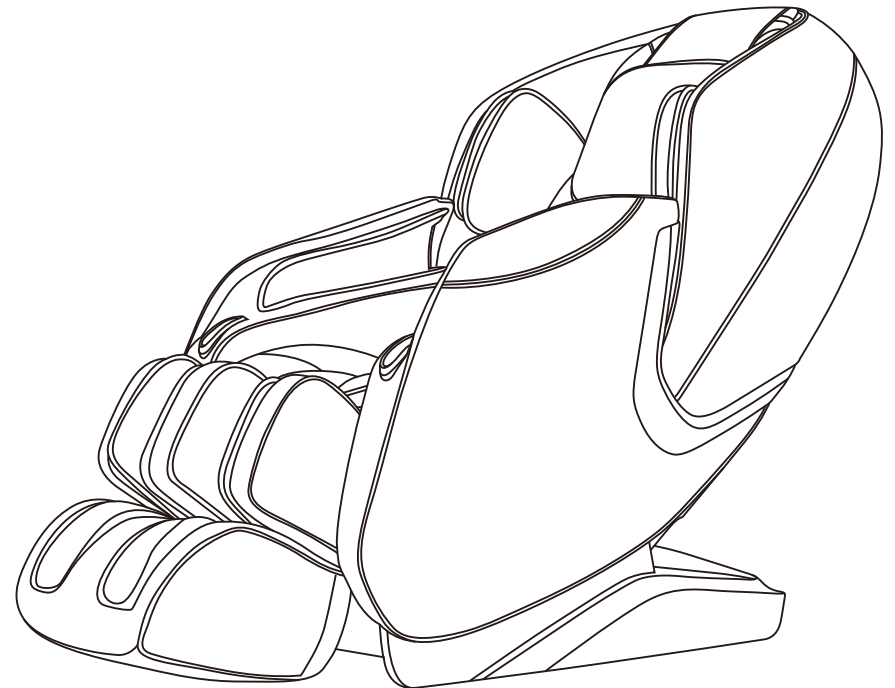

※Products refer to the actual product, without prior notice.

Thank you for purchasing this product. Please read this manual instruction carefully in order to know how to use this product correctly before operation. Please pay more attention to the important safety warnings and keep this manual book properly for future use.

Note: Our Company reserves the right to revise the design and description of this product without any further notice. Please refer to the actual color of this product.

CONTENTS

Important Safety Warning	02
Instructions de securite importantes	04
Safety and maintenance	06
Safety warning	08
Name and function of components	10
Function	11
Method of usage	12
Product specification	20

Important safety instructions

When using an electrical appliance, basic precautions should always be followed, including the following:

Read all instructions before using (this appliance)

DANGER-To reduce the risk of electric shock:

1) Always unplug this appliance from the electrical outlet immediately after using and before cleaning.

WARNING-To reduce the risk of burns, fire, electric shock, or injury to Persons:

- 1) An appliance should never be left unattended when plugged in. Unplug from outlet when not in use, and before putting on or taking off parts.
- 2) Do not operate under blanket or pillow. Excessive heating can occur and cause fire, electric shock, or injury to persons.
- 3) Close supervision is necessary when this appliance is used by, on, or near children, invalids, or disabled persons.
- 4) Use the appliance only for its intended use as described in this manual. Do not use attachments not recommended by the manufacturer.
- 5) Never operate this appliance if it has a damaged cord or plug, if it is not working properly, if it has been dropped or damaged, or dropped into water. Return the appliance to a service center for examination and repair.
- 6) Do not carry this appliance by supply cord or use cord as a handle.
- 7) Keep the cord away from heated surfaces.
- 8) Never operate the appliance with the air openings blocked. Keep the air openings free of lint, hair, and the like.
- 9) Never drop or insert any object into any opening.
- 10) Do not use outdoors.
- 11) Do not operate where aerosol (spray) products are being used or where oxygen is being administered.
- 12) To disconnect, turn all controls to the off position, then remove plug from outlet.
- 13) The appliance is intended for household and indoor use only.
- 14) Connect this appliance to a properly grounded outlet only, see grounding instructions .

Safety and maintenance

- 15) Keep children away from extended foot support (or other similar parts)
- 16) Do not use massager in close proximity to loose clothing or jewelry.
- 17) Keep long hair away from massager while in use.
- 18) Connect this appliance to a properly grounded outlet only. See Grounding Instructions

SAVE THESE INSTRUCTIONS

GROUNDING INSTRUCTIONS

This product must be grounded, if it should malfunction or breakdown. Grounding provides a path of least resistance for electric current. To reduce the risk of electric shock, this product has a cord equipped with a grounding conductor and a grounding plug. The plug must be plugged into an appropriate outlet that is properly installed and grounded in accordance with all local codes and ordinances.

DANGER: Improper connection of the equipment grounding conductor can result in a risk of electric shock, check with a qualified electrician or serviceman if you are in doubt as to whether the product is properly grounded, do not modify the plug provided with the product- If it will not fit the outlet, have a proper outlet installed by a qualified electrician

1)This product is for use on nominal 120-volt circuit,and has a grounding plug that looks like the plug illustrated in sketch on the page 16. A temporary adapter that looks like the adapter illustrated in sketches B and C may be used to connect this plug to a 2-pole receptacle as shown in sketch B. If a properly grounded outlet is not available the temporary adapter should be used only until a properly grounded outlet (sketch A) can be installed by a qualified electrician. The rigid green ear, which protrudes from the adapter, must be connected to a permanent earth like an outlet box cover grounding. Whenever the adapter is used, it must be held in place by a metal screw.

Instructions de securite importantes

lors de l'utilisation d'un appareil électrique, des précautions de bases doivent être respectées, y compris ce qui suit :

Lisez toutes les instructions avant d'utiliser l'appareil.

DANGER- Pour réduire le risque de choc électrique:

- 1) Toujours débrancher cet appareil de la prise électrique immédiatement après usage et avant nettoyage

AVERTISSEMENT- Pour réduire le risque de brûlures, d'incendie, de choc électrique ou de blessures:

- 1) Cet appareil ne doit jamais quitter votre surveillance lorsqu'il est branché. Débranchez-le de la prise lorsqu'il est inutilisé, et avant de placer ou d'enlever des pièces.
- 2) Ne pas utiliser cet appareil sous une couverture ou un oreiller. Une chaleur excessive peut provoquer un incendie, un choc électrique ou des blessures corporelles.
- 3) Soyez prudent et maintenez une surveillance accrue lorsque cet appareil est utilisé par, sur, ou près des enfants, de personnes invalides ou handicapées.
- 4) Utilisez l'appareil uniquement pour un usage habituel, comme décrit dans ce manuel. Ne pas utiliser d'accessoires non recommandés par le fabricant.
- 5) Ne jamais faire fonctionner cet appareil si le cordon ou la fiche sont endommagés, s'il ne fonctionne pas correctement, s'il est endommagé ou s'il est tombé dans l'eau. Retournez l'appareil au service technique pour examen et réparation.
- 6) Ne transportez pas cet appareil par le cordon d'alimentation ou d'utilisation comme une poignée.
- 7) Gardez le cordon loin des surfaces chauffées.
- 8) Ne jamais faire fonctionner l'appareil en obstruant les ouvertures d'air. Gardez les ouvertures à l'air, libre de peluches, de cheveux, etc.
- 9) Ne jamais laisser tomber, ou insérer d'objet dans les ouvertures.
- 10) Ne pas utiliser à l'extérieur.
- 11) Ne pas utiliser dans les lieux où des aérosols (vaporisateurs) sont utilisés, ni là où l'oxygène est administré.
- 12) Pour débrancher, mettre tous les boutons de l'appareil sur la position arrêt, puis retirer la fiche de la prise.
- 13) L'appareil est destiné à un usage domestique et à l'intérieur seulement.
- 14) Connectez cet appareil à une prise correctement reliée à la terre. Voir les instructions de mise à la terre.

Securite et entretien

- 15) Éloignez les enfants du support de pied ouvert (ou des autres pièces semblables).
- 16) Ne pas utiliser de massage à proximité des vêtements amples ou des bijoux.
- 17) Garder les cheveux longs à l'écart de masseur en cours d'utilisation.
- 18) Raccordez cet appareil à une prise correctement mise à la terre.
- 19) Ne pas utiliser l'appareil de massage à proximité des vêtements amples ou des bijoux.
- 20) Gardez les cheveux longs loin du masseur pendant l'utilisation.

CONSERVER CES INSTRUCTIONS INSTRUCTIONS DE BASES

Ce produit doit être relié à la terre. Si il dysfonctionne ou tombe en panne, la terre fournit un chemin de moindre résistance pour le courant électrique afin de réduire le risque de choc électrique. Cet appareil est équipé d'un cordon avec un conducteur de mise à la terre des équipements et une prise de terre. La fiche doit être branchée dans une prise appropriée qui est correctement installée et mise à la terre conformément à la réglementation locale.

DANGER: un mauvais branchement de l'équipement à la prise de terre, peut entraîner un risque de choc électrique. Consultez un électricien qualifié si vous avez des doutes quant à savoir si le produit est correctement mis à la terre. Ne pas modifier la fiche fournie avec le produit si elle ne rentre pas dans la prise. Adressez vous à un électricien qualifié le cas échéant.

1) Ce produit est destiné à être utilisé sur un circuit de 120 volts, et possède une fiche de mise à la terre semblable à la fiche illustrée sur le croquis de la page 16. Un adaptateur temporaire qui ressemble à l'adaptateur illustré sur le croquis B et C peut être utilisé pour brancher cette fiche à un réceptacle 2-pole, comme indiqué sur le croquis B. Si une prise de terre n'est pas disponible, l'adaptateur temporaire ne doit être utilisé que jusqu'à une prise de terre correcte (croquis A) pour être installé par un électricien qualifié. L'oreille rigide de couleur verte, qui dépasse de l'adaptateur, doit être connectée à une terre permanente comme un couvercle de boîte de sortie mise à la terre. Chaque fois que l'adaptateur est utilisé, il doit être maintenu en place par une vis en métal.

S'il vous plaît noter que lorsque ne pas coincer votre détection des doigts Avant le nettoyage ou la réparation doivent couper l'alimentation

Safety and Maintenance

1. Important Safety Warning.

- Please do not allow children to touch move-able parts of this product.
 - Please use a well-grounded power supply suited for this product.
 - Please pull out the plug after use or before cleaning to avoid injury or damage to the product.
 - Please operate this product according to this manual instructions.
 - Do not use accessories which are not recommended.
 - Do not use this product outdoors.
 - Please read this manual instruction carefully before operation.
 - Any other usage that is not listed in this manual instruction is forbidden.
 - 20 minutes of usage each time is recommended.
 - Please don't use product if the leather is broken or damaged.
 - Please don't use product if the cover or leather is damaged.
 - Please don't use product if the radiator hole is covered or blocked.
 - Please don't drop anything into this product.
 - Please don't fall asleep while using this product.
 - Please don't use product if under the influence or feeling unwell.
 - Please don't use product within one hour after having meal.
 - Please don't make the massage function too strong for avoiding Injury.
- **Environment for usage.**
- Please do not use the product in high temperature settings and moist environments such as the bathroom.
 - Please do not use in places where the environmental temperature changes sharply.
 - Please don't use it under heavy-dusted or caustic environment.
 - Please don't use it where there is not enough space or good ventilation.
- **People who are not suitable to use this product.**
- People who are suffering from osteoporosis are not suitable to use this product.
 - People who are suffering from heart disease or carrying electronic medical equipment such as heart pacemaker are not suitable to use this product.
 - People who are suffering from fever are not suitable to use this product.
 - Pregnant women or women that are on their menstrual cycle are not suitable to use this product.
 - People who are injured or with skin disease are not suitable to use this product.
 - Children under 14-years old or people mentally disabled are not allowed to use this machine without being supervised.
 - People who are told by doctor to have rest or people who feel unwell are not suitable to use this product.
 - People whose bodies are wet are forbidden to use this product.
- **Safety.**
- Check the voltage to see if it is suitable to the specification of this product.
 - Don't use wet hand/s to pull the plug.
 - Don't make water go inside this product to avoid electric shock or cause damage to this product.
 - Don't damage the wires or change the circuit of this product.
 - Don't use wet cloth to clean the electric parts such as the switch and plug.

Safety and Maintenance

- Be away from this product under the power cut state to avoid injury if the power comes back suddenly.
- Stop using this product while it's behavior is abnormal, and please consult local agent immediately.
- Stop using this product if you feel unwell, and please consult a health care doctor.
- This appliance is not intended for use by persons (including children) with reduced physical, sensory or mental capabilities, or lack of experience and knowledge, unless they have been given supervision or instruction concerning use of the appliance by a person responsible for their safety.
- Children should be supervised to ensure that they do not play with the appliance.
- If the supply cord is damaged, it must be replaced by the manufacturer, its Service agent or similarly qualified persons in order to avoid a hazard.

5. Maintenance.

- This product should be maintained by certain appointed agents, users are prohibited to disassemble or maintain by themselves.
- Please don't forget to turn off the power after usage.
- Don't use this product if the socket is loose.
- If this product will be left unused for long, please curl up the wires and reserve this product in a dry and dustless environment.
- Do not reserve this product under high temperatures or near fire and avoid longtime direct sunshine.
- If the detachable cord / supply cord is damaged, it must be replaced by the manufacturer, its service agent, or similarly qualified persons in order to avoid a hazard.
- Please clean this product with a dry cloth. Don't use a thinner, benzene, or alcohol.
- The mechanical components of this product are specially designed and made, it is not necessary to be specially maintained.
- Don't use edged item to thrust this product.
- Don't roll or pull this product above uneven ground, it should be lifted before moving.
- Please use it intermittently; don't make this product work continuously for long.

6. Solution of ordinary malfunctions.

- It is natural if the motor sounds while in usage.
- If the controller can't work normally, please check the plug and socket if they are connected strongly and make sure the switch is turned on.
- If the rated working time is over, the product will automatically activate the power-off button. If this product works continuously for long, the temperature protector will make the product automatically power-off, it should be used again after half an hour's rest.

Safety Warning

⚠ Warning

When the footrest is lifting, people should not apply pressure on the footrest to avoid the massage chair falling forward to damage the product or cause personal injuries.

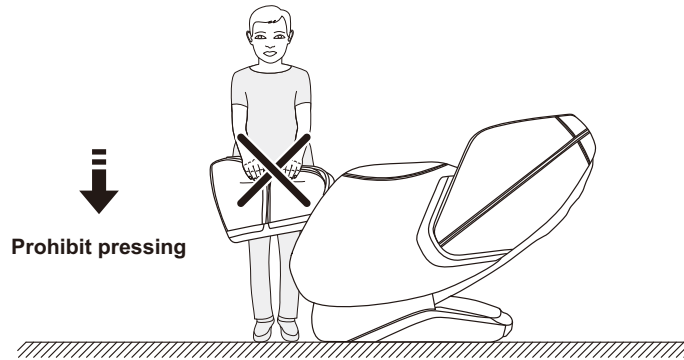

⚠ Warning

Before sitting on the massage chair, make sure that the massage hand stays in the seat cushion position to avoid discomfort to the buttocks when the body is pressing down and at risk to causing damage to the massage hands.

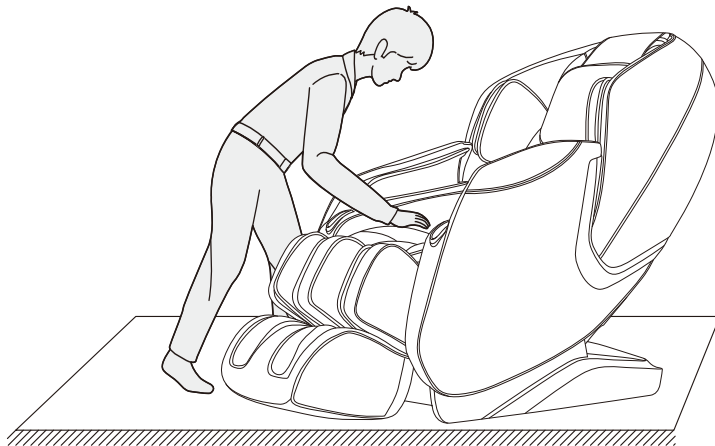

Safety Warning

⚠ Warning

Do not strive to pull out the control cable or power cord during the standby or power-on state to avoid product damage or electrocution accidents. It is advised that you unplug the controller cable and power cord and put them out of reach from anyone including children, adults, and pets after you use the chair.

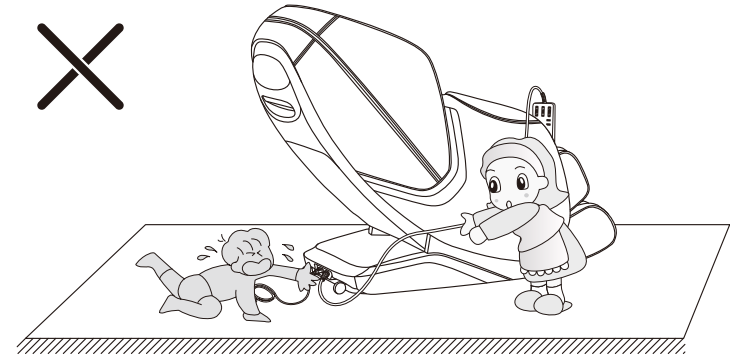

⚠ Warning

When starting the zero gravity lying function, be sure to check whether there are children and pets under the bottom of the footrest and backrest. If not this may cause the product damage or personal injuries.

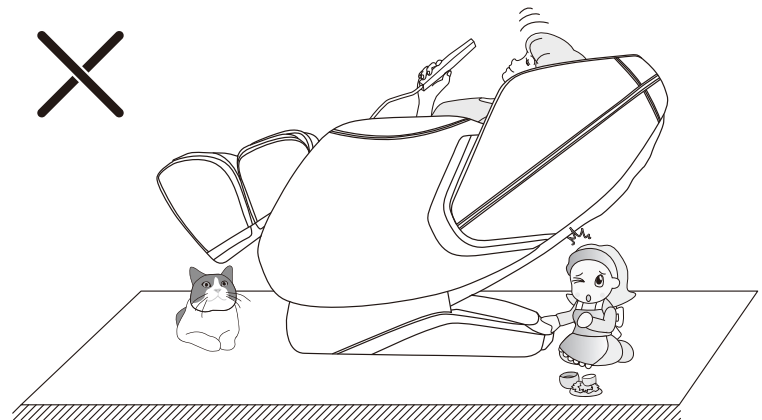

Name and function of components

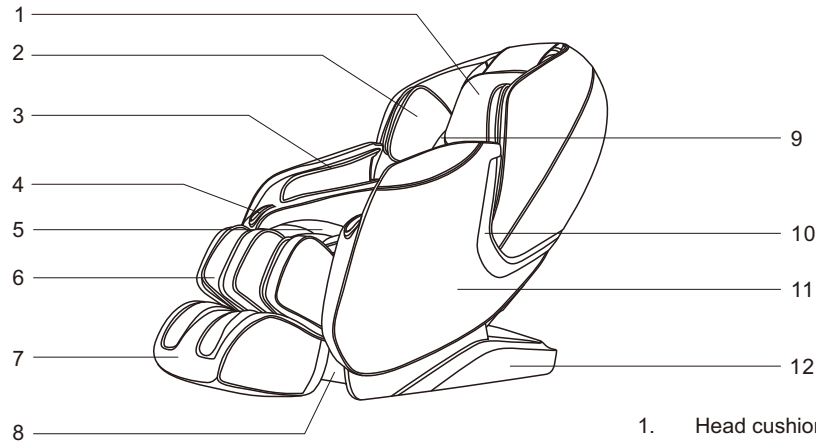

1. Head cushion
2. Upper arm air pressure component
3. Arm air pressure component
4. Remote controller and mobile phone holder
5. Seat cushion
6. Leg rest frame
7. Foot rest frame
8. Calf retaining plate
9. Back cushion
10. Armrest decoration
11. Armrest
12. Side cover

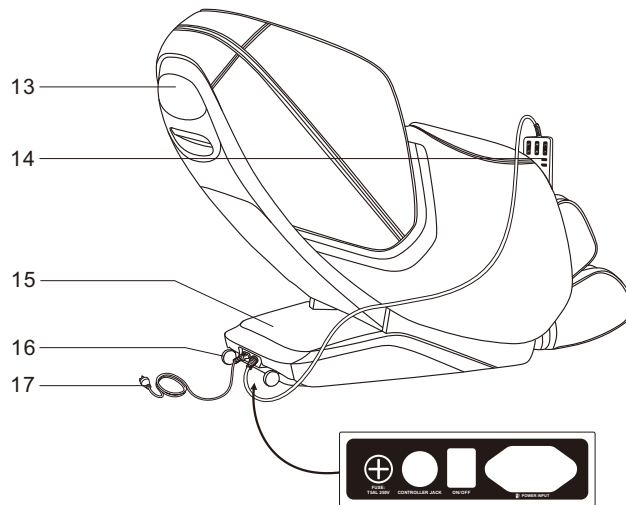

18. Fuse box
19. Hand controller cable socket
20. Power switch
21. Power cord socket

Function

- Designed with a set of vertically movable, four wheel driven muted intelligent massage hands.
- There are five kinds of simulated massage techniques: shiatsu, kneading, tapping, knocking, kneading and tapping.
- Set with six kinds of characterized auto massage function: comfort, ease, full body, neck& shoulder, back & waist massage, stretch.
- It has the upper body manual massage function (area, fixed point, full back, neck shoulder, back waist, five massage parts selection, each massage technique speed can be adjusted in three steps. In the fixed point and partial module state, the massage ball can move up and down to adjust the massage point accurately. In the state of tapping, shiatsu and knocking massage, the width between the two kneading balls is adjustable with three levels: wide, medium and narrow..
- Air pressure massage function with three modes: Full body air pressure, arms air pressure, leg air pressure, with 3 intensity adjustable.
- With sole roller massage function
- The footrest can be extended to suit different leg lengths.
- The motor drives the footrest and the backrest synchronically and lay down automatically two regulatory functions.
- The backrest of the massage chair should be kept at least 275 mm away from the wall.
- Natural magnet is placed at the heel of the heel.
- The SL-type backrest track fits the human body curve, and the backrest is in a zero-gravity state when lying down.
- The chair will be reset when switch is turned off. The massage hands will be restore as well.

Method of usage

Note: The specific displays refer to the actual object of this product!

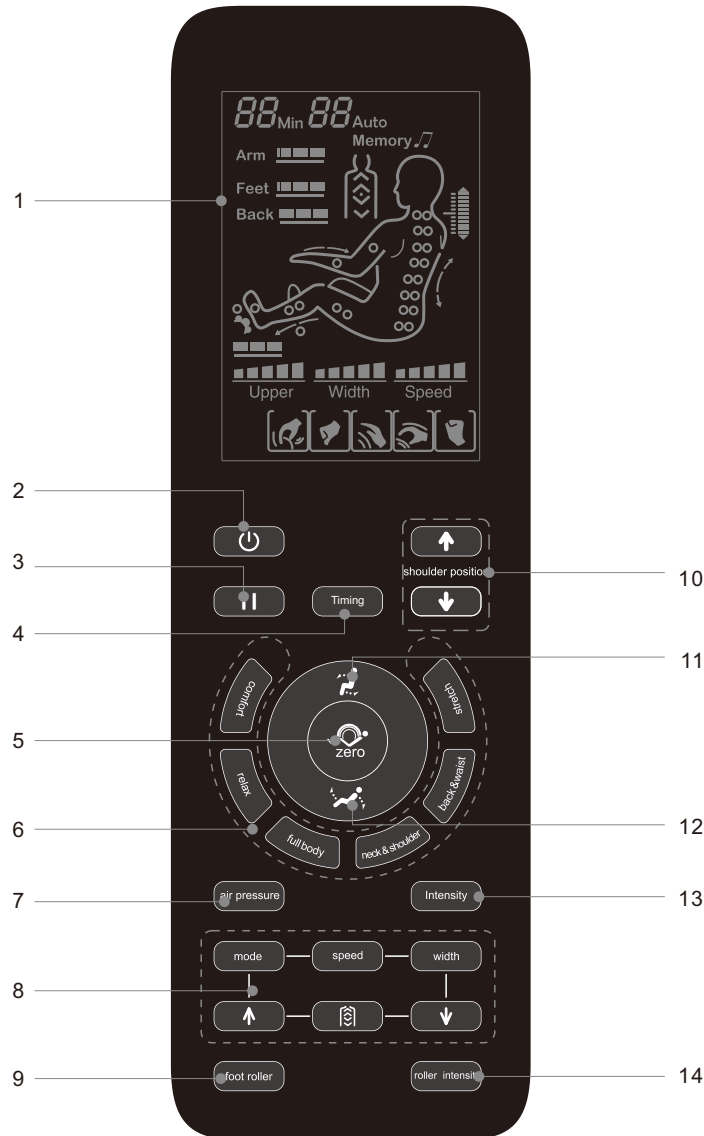

Method of usage

- 1.LCD display:
 - Display all massage functions
- 2.Power switch:
 - Turn on or Turn off all massage functions.
- 3.Pause button:
 - Stop or start all massage functions.
- 4.Timing button
 - Time setting
- 5.Auto lying Button
 - There are three automatic lying position, choose your favorite one.
- 6.Auto massage Button
 - Please refer to page 10 of this manual for details.
- 7.Air pressure mode Button
 - Turn on/off the air pressure massage function (refer to page 11 of this manual for details).
- 8.Manual massage button
 - Please refer to page 10 of this manual for details.
- 9.Sole roller button
 - Turn on/off sole roller massage function
- 10.Shoulder adjust button
 - Make adjustments on shoulder acupressure points.
- 11.Lifting button
 - Rise up the backrest and lower down the footrest.
- 12.Lying button
 - Lower down the backrest and raise up the footrest.
- 13.Air pressure intensity button
 - Make adjustments on the air pressure intensity.
14. Roller intensity button
 - Make adjustments on the sole roller intensity.

Method of usage

1. Switch power supply on



2. Start to massage

- ① Press the power button to start massage.
- ② The chair conduct a body scan and testing your shoulder position and massage point, waiting for detection to be completed
- ③ If the body scan deviates from the actual shoulder position, adjust the up and down buttons to the appropriate position. There are 10 levels to adjust, and you have 10 seconds to make the adjustment. After 10 seconds, enter in to massage automatically.

Button	Description	Display
↑	Move the massage balls upward to a suitable position	↑
↓	Move the massage balls downward to a suitable position	↓

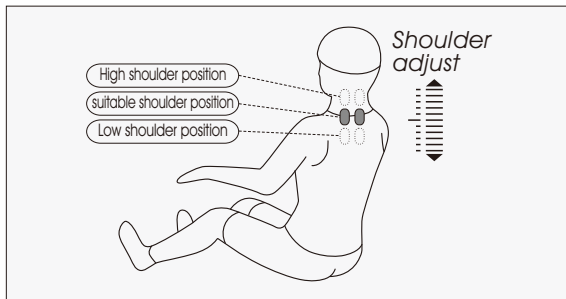

During the body scan process (the shoulder position adjustment icon will be displayed on the screen of the controller and sounds "DiDi", and then press the shoulder position up and down keys to adjust the shoulder position). You can also press any of the six automatic massage function keys (comfort, ease, full body, neck shoulder, back waist, stretch) and start massage (you can skip step 4 directly).

- ④ Choose massage function and start massage

Method of usage

· Features automatics massage









Function	Button	Description	Display
Features automatics massage	Comfort	Loosen the muscles.	F1 Auto
	Relax	Deep-tissue massage throughout key acupressure points to relax the sore area.	F2 Auto
	Full body	Full body massage, relaxing the sore areas.	F3 Auto
	Neck & shoulder	Focused on the neck and shoulder areas	F4 Auto
	Back&waist	Focus on the back waist area.	F5 Auto
	Stretch	The footrest and backrest lifting together, combined with air pressure massage to stretch the legs, remove fatigue, and recover your body.	F6 Auto

· Upper body manual massage





Function	Button	Massage ball adjustment	Display
Massage	mode	Shiatsu Speed, width	👉
		Kneading: Speed	👉
		Tapping: Speed, width	👉
		Kneading and tapping: speed	👉
		Knocking: Speed, width	👉
Speed	speed	3 adjustable level	▬▬▬ Speed
Width	width	3 adjustable level	▬▬▬ Width
Back stretch	👉	The massage hand stay in fixed position	👉 H0
		The massage hand will move up and down in a partial position	👉 H1
		The massage hand will move up and down on full back	👉 H2
		The massage hand will move up and down on back and shoulder area	👉 H3
		The massage hand will move up and down on back and waist area	👉 H4
	↑	Message position adjustment (in fixed point, partial mode, the message position can be adjusted).	Message hand move up
↓	Message hands go down		

Method of usage



· Air pressure massage

Function	Button	Description	Display
Air pressure mode		Full air pressure: air pressure massage on arm, leg and foot.	Arm  Feet 
		Arm: Air pressure massage focus on arm.	Arm 
		Legs: Air pressure massage focus on leg and foot.	Feet 
Intensity		3 levels adjustable	Arm  Feet 



· Foot roller manual massage function

Function	Button	Description	Display
Foot roller		The foot roller massage function turn on or off.	
Roller intensity		After the foot roller massage is turned on, the massage intensity can be adjusted: mild, medium and strong.	

· Pause/start massage button

Function	Button	Description	Display
Pause/Start		Press this button during the massage, all massage actions are stopped immediately (the timer will continue to count down), and press this button again, all the massage will be resume.	

· Backrest and calf position adjust

Function	Button	Description
Lifting button		Press and hold this button, it will raise the backrest and lower the footrest simultaneously, a "Di.Di" sound indicates that it has reach the maximum position and stops. Press this button again while lifting, then immediately stop.
Lying button		Press and hold this button, it will lower the backrest and raise the footrest simultaneously, a "Di.Di" sound indicates that it has reach the maximum position and stop. Press this button again while lifting, then immediately stop.
Automatic lying mode		When pressing this button, it will automatically place you into one position, total three position switch.

· Other manual functions

Function	Button	Description	Display
Timing		Timing adjustment, press one time, add 5 minutes, not more than 30 minutes. If it exceeds 30 minutes, it will return to 5 minutes.	<i>20min</i>

Method of usage

3. Turn off the power and stop massage.

- When pressing the power button during the massage, it will stop all the massage functions immediately, the backrest and footrest will go back to the default position. And when the massage times up, the massage hand will go back to the default position, all the massage function will stop, the backrest and footrest will not go back to the default position.
- Cut off the power of the whole machine. Figure (switch power off)

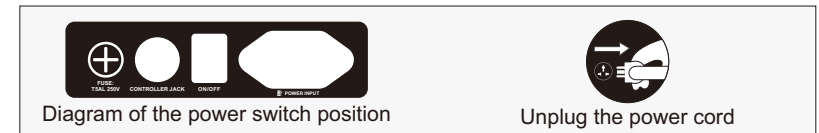

4. The calf installation.

1. After connecting the air hose and the wire harness on the calf and the massage chair, untie the fixed line belt and insert the connecting part into the frame (Figure 1).
2. Place the calf fixing block on the two sides of the round tubes of the calf (Figure 2).

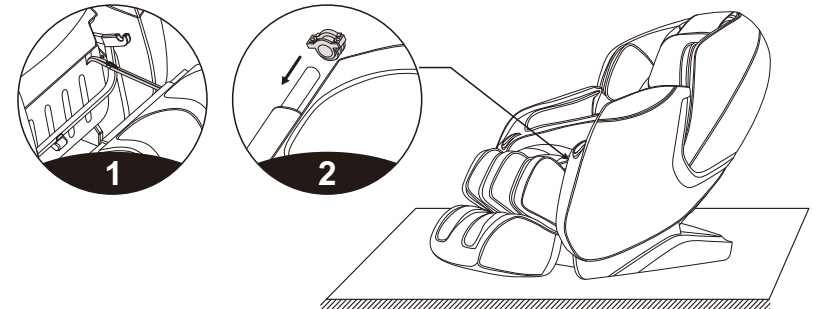

3. Hang the calf of the fixed block on the massage chair frame hook (Figure 3).
4. Then use 4 (each side two pcs) M4 screws to fasten the calf to the massage chair, check whether there is any abnormality, whether the pipeline is folded or not, and finish the installation (Figure 4).

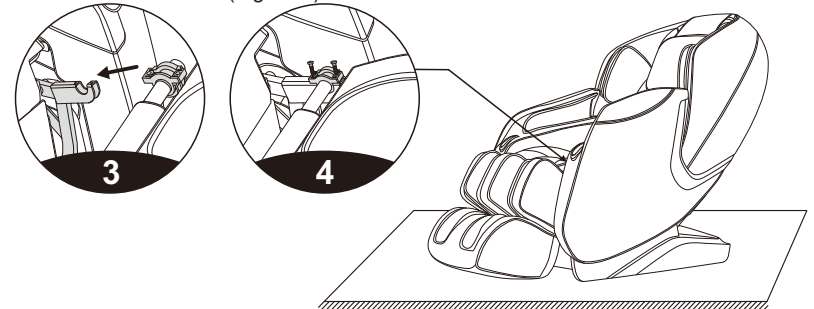

Method of usage

5. Head cushions and backrest pad's dismounting and use manual

- The head cushion allows you to control the intensity of the neck and shoulder massage. You can decide whether to use the head cushion (Recommend to use). The backrest cushion and the backrest is connected by a zipper (1), head cushion and the backrest cushion connected by the Velcro as show in the illustration (2).

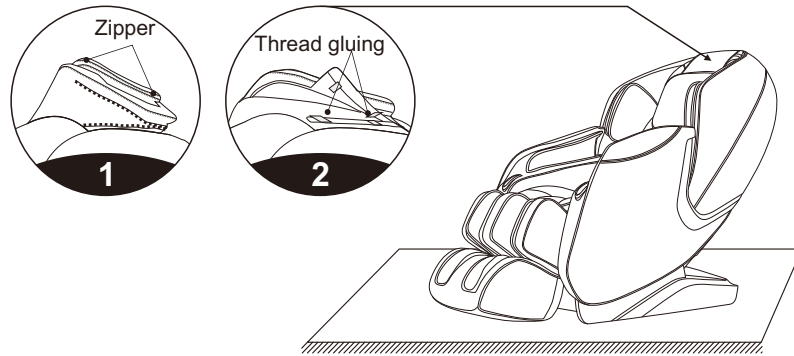

6. Floor Protection

- Do not put the heavy massage chair directly on the wood floor for it may cause damage the floor, so please place a carpet or other object to avoid this damage.

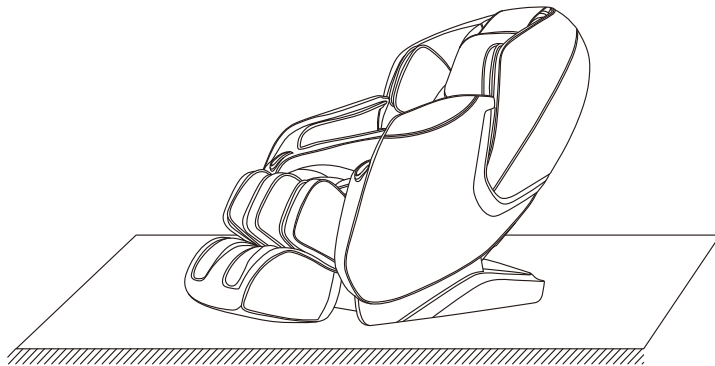

Caution: Do not move the chairs with its wheels on the wooden floor, rough ground, or in a narrow space. Two people are required to lift the chair. During the lifting period, take the calf rest end sealing plate and backrest cover grooves as the force-bearing point(Please do not lift armrest directly.)

Method of usage

7. Method of movement

- Make sure that all wires are far above the ground, tilt the backrest backward to a certain degree (with the gravity center resting on the wheels), push the chair forward or backward with your hands and finally resume the chair to the normal position in a slow and gentle manner.

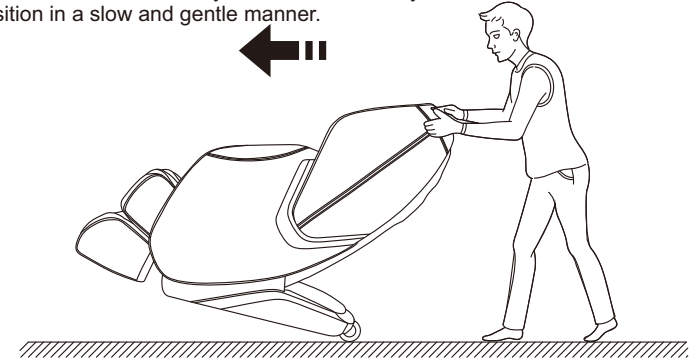

Note: During movement you must turn off the power first and then unplug the power cord and the controller cord.

8. The distance from the wall

- When you place the massage chair, the backrest should always be kept at least 275mm away from the wall. If the backrest is too close to the wall, it will be collide the wall and cause damage to the product when it laying down.

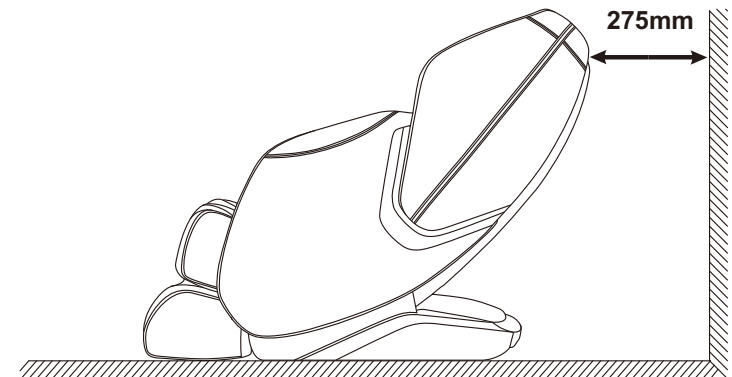

Product specification

Model: Aster
Name: Massage Chair
Rated voltage: 110-120V~ 60Hz
Rated power input:110W
Rated time: 20Min
Safety structure: Class I

Material introduction: PVC, PA, steel parts and electric & electron parts

MATERIAL	PU	LEATHER	CLOTH	WOOD